

Selection diagram

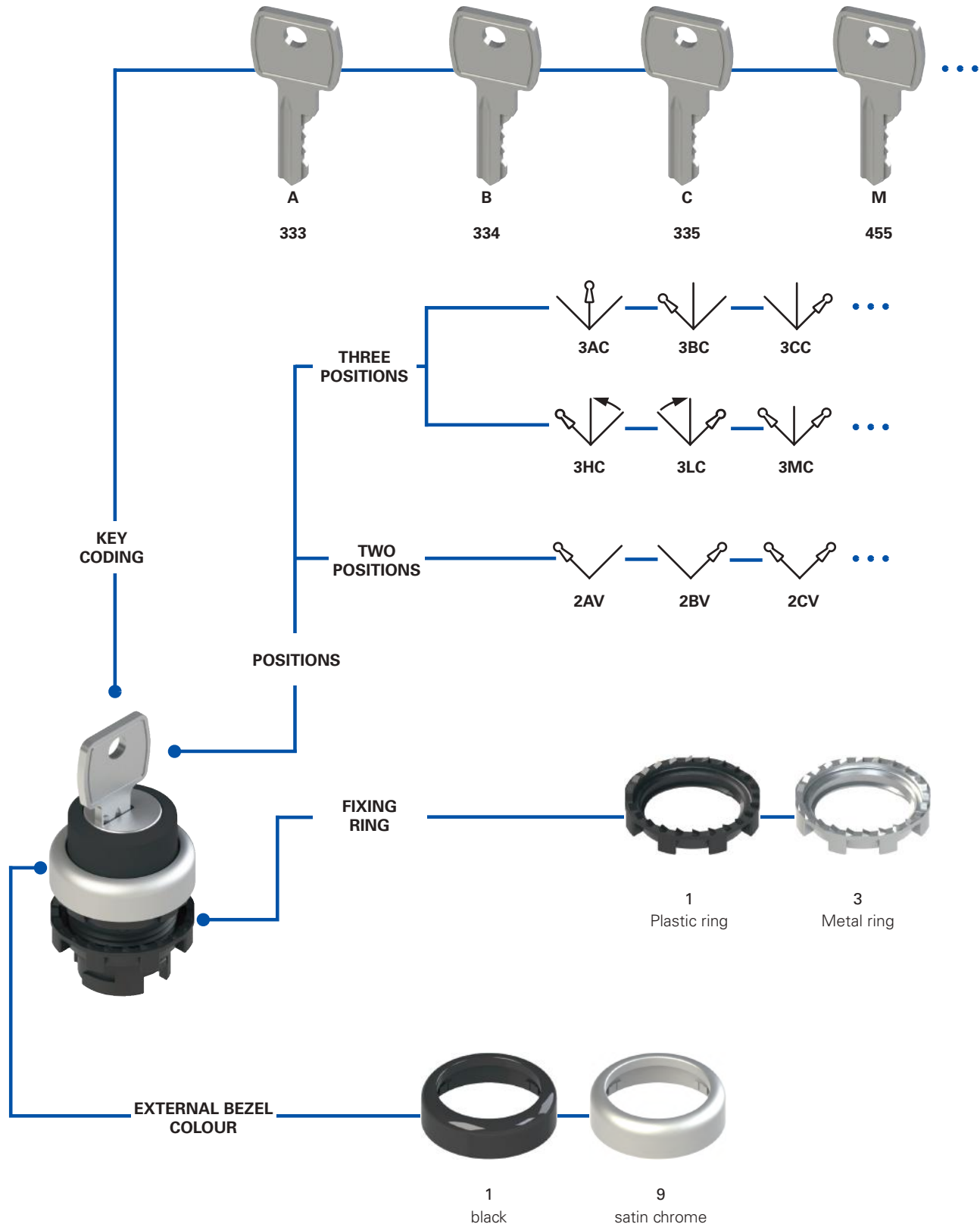





















Code structure **Attention!** The feasibility of a code number does not mean the effective availability of a product. Please contact our sales office.

article options

E2 1SC2ACA11AA-T6



Fixing ring and shaped ring	
1	Plastic ring (standard)
2	Plastic fixing ring and shaped ring
3	Metal ring
4	Metal ring and shaped ring

Ambient temperature	
	-25°C ... +80°C (standard)
T6	-40°C ... +80°C

Positions and key removal			
2AV 	3AC 	3HC 	
2BV 	3BC 	3LC 	
2CV 	3CC 	3MC 	
2DV 	3DC 	3NC 	
2AC 	3EC 	3PC 	
2BC 	3FC 	3QC 	
2DC 	3GC 	3RC 	

Legend:  Maintained  Spring-return  Key extraction position

Cams and actuators	
A	cam for 2-position selector switch for 3-slot base
E	cam for 3-position selector switch for 3-slot base
Q	cam for 2-position selector switch for 4-slot base
R	cam for 3-position selector switch for 4-slot base

Marking type	
A	no inscription (standard)
C	 for selector switches only, positions 2AC, 2BC, 2DC
D	 for three-position selector switches only
E	 for selector switches only, positions 2AV, 2BV, 2CV, 2DV

Other combinations on request.

Key coding	
A	Key coding 333 (standard)
B	Key coding 334
C	Key coding 335
...	...
M	Key coding 455

Other key codes on request.

Bezel colour	
1	black (standard)
9	satin chrome (standard)

Selector colour	
1	black



Main features

- Protection degrees IP67 and IP69K
- Maintained or spring-return version

Quality marks:



IMQ approval: CA02.04805
 UL approval: E131787
 EAC approval: RU C-IT.A135.B.00454

Technical data

General data

Protection degree:	IP67 acc. to EN 60529 IP69K acc. to ISO 20653
Ambient temperature:	-25°C ... +80°C (standard) -40°C ... +80°C (T6 option)
Safety parameter B_{10D} :	600,000
Mechanical endurance:	300,000 operating cycles
Max. actuation frequency:	3600 operating cycles/hour
Actuating force at limit of travel:	0.07 Nm (without contacts)
Maximum travel:	60° (2 stable positions) 40° (2 momentary positions) ±60° (3 stable positions) ±40° (3 momentary positions)
Tightening torque of the fixing ring:	2 ... 2.5 Nm
Utilization requirements:	see page 149

In compliance with standards:

IEC 60947-1, IEC 60947-5-1, IEC 60204-1, EN 60947-1, EN 60947-5-1, EN 60204-1, EN 50581, UL 508, CSA 22-2 N°14

⚠ Installation for safety applications:

Use only contact blocks marked with the symbol ⊖. The safety circuit must always be connected to **NC contacts** (normally closed contacts: .1-.2).

Compliance with the requirements of:

Low Voltage Directive 2014/35/EU, EMC Directive 2014/30/EU, RoHS Directive 2011/65/EU.

Positive contact opening in conformity with standards:

IEC 60947-5-1, EN 60947-5-1.

Features approved by UL

For Use on a Flat Surface of a Type 1, 4X, 12 and 13
 Tightening torque 2.0 Nm

General data

Protection degrees IP67 and IP69K

IP69K
IP67

These devices are designed to be used in the toughest environmental conditions and they pass the IP67 immersion test acc. to EN 60529. They can therefore be used in all environments where maximum protection degree of the housing is required. Due to

their special design, these devices are suitable for use in equipment subjected to cleaning with high pressure hot water jets. These devices meet the IP69K test requirements according to ISO 20653 (water jets with 100 bar and 80°C).

Metal fixing ring



The fixing ring in metal is particularly suitable for those applications which require tighter fitting of the panel-mounted device, such as for example in metal panels having holes without reference notches.

Shaped ring

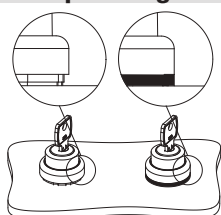

The shaped ring can be used when no label holder or other devices are applied; it prevents dirt and other residues from settling between the selector switch and the panel or housing. This turns out to be particularly useful in the sectors where high standards of cleanness and hygiene are required.

Actuators for selector switches





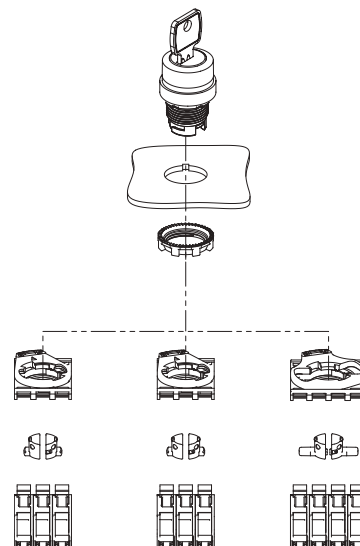

Three types of actuators are available, which activate the cursors of the contacts combined with the selector: a white actuator allowing the commutation of a single contact block, and a black or grey actuator allowing the simultaneous commutation of two contact blocks next to each other.

The white, black (3-slot base) and grey (4-slot base) actuators can be removed and replaced at any moment. This allows to configure at will the switching type executed by the selector on the contacts.

















Selection table for key selector switches





Actuator colour and engraving	Two positions	with key	
		black bezel	satin chrome bezel
● black		E2 1SC2AVA11AA	E2 1SC2AVA19AA
		E2 1SC2BVA11AA	E2 1SC2BVA19AA
		E2 1SC2CVA11AA	E2 1SC2CVA19AA
		E2 1SC2DVA11AA	E2 1SC2DVA19AA
		E2 1SC2ACA11AA	E2 1SC2ACA19AA
		E2 1SC2BCA11AA	E2 1SC2BCA19AA
		E2 1SC2DCA11AA	E2 1SC2DCA19AA

The standard colour of the selectors in the above-mentioned codes is **BLACK**. Other colours on request.
Key selectors switches can be customized with symbols and inscriptions on request.
All keys of the selector switches have the 333 key coding. Other codes on request.



Actuator colour and engraving	Three positions	with key	
		black bezel	satin chrome bezel
● black		E2 1SC3ACE11AA	E2 1SC3ACE19AA
		E2 1SC3BCE11AA	E2 1SC3BCE19AA
		E2 1SC3CCE11AA	E2 1SC3CCE19AA
		E2 1SC3DCE11AA	E2 1SC3DCE19AA
		E2 1SC3ECE11AA	E2 1SC3ECE19AA
		E2 1SC3FCE11AA	E2 1SC3FCE19AA
		E2 1SC3GCE11AA	E2 1SC3GCE19AA
		E2 1SC3HCE11AA	E2 1SC3HCE19AA
		E2 1SC3LCE11AA	E2 1SC3LCE19AA
		E2 1SC3MCE11AA	E2 1SC3MCE19AA
		E2 1SC3NCE11AA	E2 1SC3NCE19AA
		E2 1SC3PCE11AA	E2 1SC3PCE19AA
		E2 1SC3QCE11AA	E2 1SC3QCE19AA
		E2 1SC3RCE11AA	E2 1SC3RCE19AA

The standard colour of the selectors in the above-mentioned codes is **BLACK**. Other colours on request.
Key selectors switches can be customized with symbols and inscriptions on request.
All keys of the selector switches have the 333 key coding. Other codes on request.

Legend:  Maintained  Spring-return  Key extraction position

3-slot mounting adapter

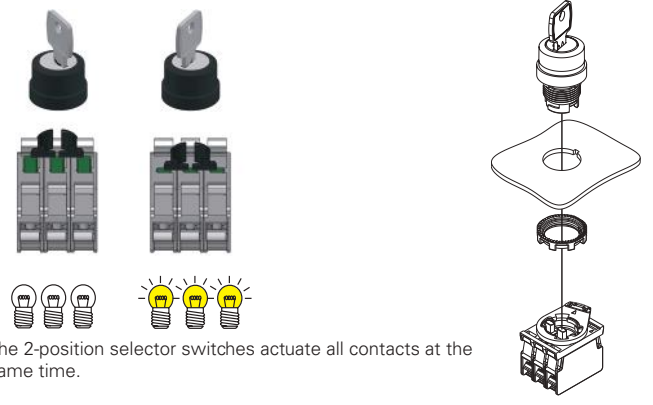

The 2-position selector switches actuate all contacts at the same time.

4-slot mounting adapter

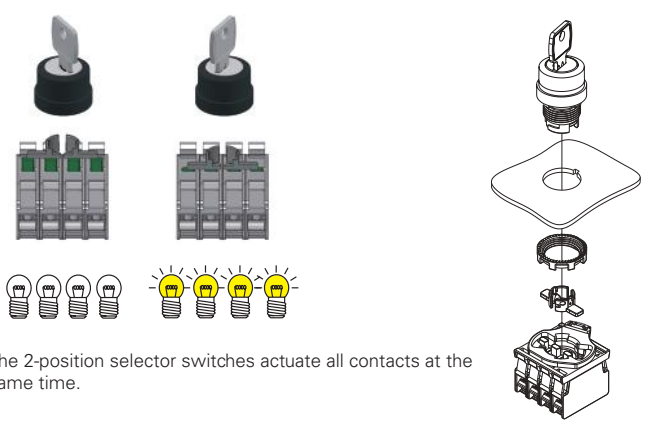

The 2-position selector switches actuate all contacts at the same time.

3-slot mounting adapter

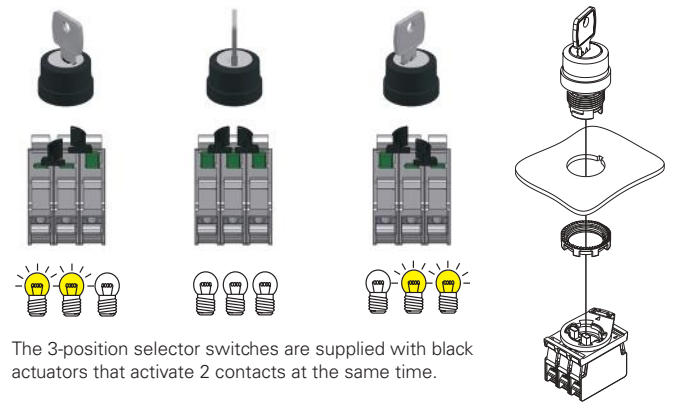

The 3-position selector switches are supplied with black actuators that activate 2 contacts at the same time.

4-slot mounting adapter

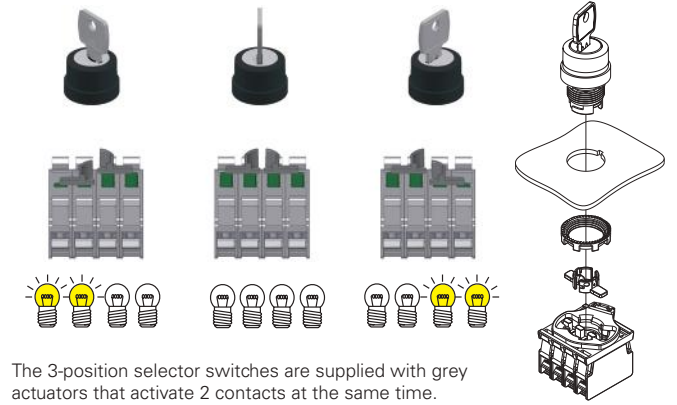

The 3-position selector switches are supplied with grey actuators that activate 2 contacts at the same time.

Complete units with two- or three-position key selectors



Actuator colour and engraving	Positions	Contacts			2 positions
		pos. 2	pos. 3	pos. 1	black bezel
● black		-	1NO	-	E2 AC-DXBC1601 E2 1SC2AVA11AA + E2 1BAC11 + E2 CP10G2V1
● black		-	1NO	-	E2 AC-DXBC1605 E2 1SC2CVA11AA + E2 1BAC11 + E2 CP10G2V1
● black		-	1NO	-	E2 AC-DXBC1606 E2 1SC2DVA11AA + E2 1BAC11 + E2 CP10G2V1

Other combinations on request.
Key with key coding 333.

Actuator colour and engraving	Positions	Contacts			3 positions
		pos. 2	pos. 3	pos. 1	black bezel
● black		1NO	-	1NO	E2 AC-DXBC1607 E2 1SC3DCE11AA + E2 1BAC11 + E2 CP10G2V1 + E2 CP10G2V1

Other combinations on request.
Key with key coding 333.

Legend: Maintained Spring-return Key extraction position

→ For data regarding contact blocks, please see the respective chapters.

Minimum distances for installation

All values in the drawings are in mm

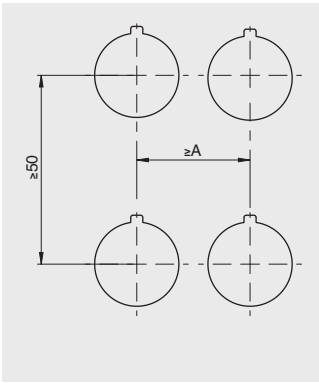

3-slot mounting adapter
A=30 mm
4-slot mounting adapter
A=40 mm

Maximum number of contact blocks

3-slot mounting adapter

E2 •SC•••••• key selector switch



maximum number:
6 contact blocks
3 levels

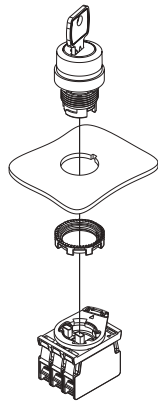

4-slot mounting adapter

E2 •SC•••••• key selector switch

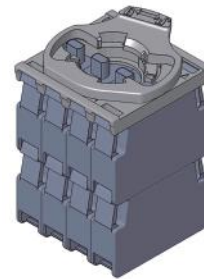

maximum number:
8 contact blocks
2 levels

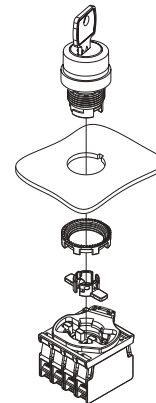

Contact block



Alternative position contact block

The mounting of the actuators for 4-slot base must be carried out after fixing the selector.

Dimensions

All values in the drawings are in mm

Key selector switch

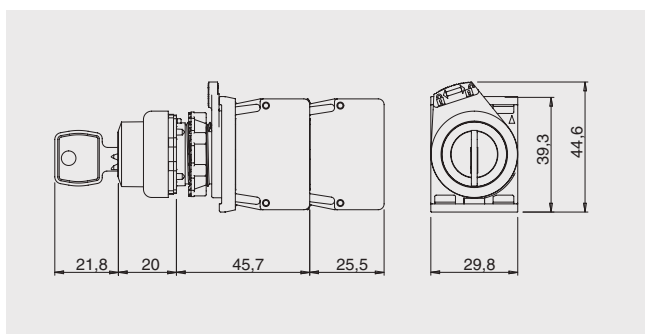

→ The 2D and 3D files are available at www.pizzato.com

Locking keys

Article	Description
VE KE1A00-PY333	Locking key



Order only if further keys besides the supplied one are needed.
Key with key coding 333.
Other codes on request.

Actuators

Packs of **10 pcs.**

Article	Description
 VE AS1212	Black closed actuator for 3-slot base. Actuates 2 contact blocks at the same time.
 VE AS1213	White open actuator for 3-slot base. Actuates 1 contact block.
 VE AS1216	Grey closed actuator for 4-slot base. Actuates 2 contact blocks at the same time.

Note: 2 actuators needed for each selector.

Shaped ring

Packs of **50 pcs.**

Article	Description
 VE GP12H1A	Shaped ring for single device

Not applicable in presence of label holders, adapters from Ø 22 to Ø 30 mm, guards or protection caps.

Fixing ring

Packs of **20 pcs.**

Article	Description
 VE GF720A	Metal fixing ring

Accessories

→ More ACCESSORIES on page 143

